

1.8A Current Limited P-Channel Switch

General Description

The AAT4601A SmartSwitch is a member of Skyworks' Application Specific Power MOSFET™ (ASPM™) product family. It is a 1.8A current limited P-channel MOSFET power switch designed for high-side load switching applications. This switch operates with inputs ranging from 2.7V to 5.5V, making it ideal for both 3V and 5V systems. An integrated current-limiting circuit protects the input supply against large changes in load current which could cause the supply to fall out of regulation. The AAT4601A has protection from thermal overload which limits power dissipation and junction temperatures. The maximum current limit level will guarantee that 1.8A can be delivered to the load; the actual threshold is programmed with a resistor from the SET pin to ground. The quiescent supply current is typically 12µA. In shutdown mode, the supply current decreases to less than 1µA.

The AAT4601A is available in a Pb-free, 8-pin SOP or MSOP package and is specified over the -40°C to +85°C temperature range.

Features

- Input Voltage: 2.7V to 5.5V
- Programmable Over-Current Threshold
- Low Quiescent Current
 - 12µA Typical
 - Less Than 1µA with Switch Off
- Only 2.5V Needed for ON Control
- Thermal Shutdown
- Fault Flag
- 2ms Fault Blanking
- Under-Voltage Lockout
- Temperature Range: -40°C to +85°C
- 4kV ESD rating
- UL Approved—File No. E217765
- 8-Pin SOP or MSOP Package

Applications

- Hot Swap Supplies
- Notebook Computers
- Peripheral Ports
- USB Ports



UL Recognized Component

Typical Application

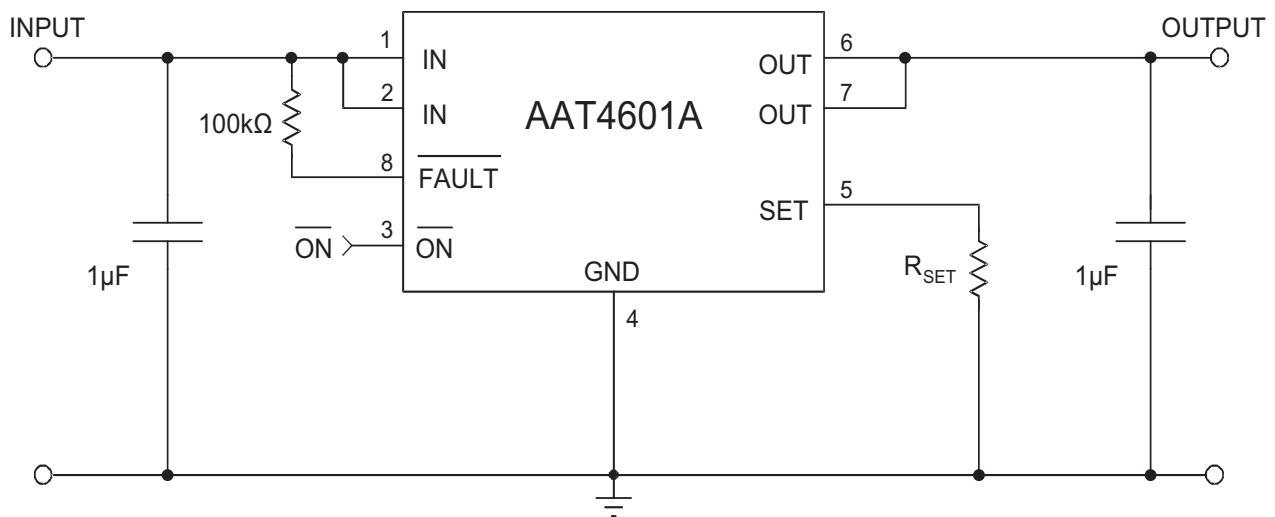

AAT4601A

1.8A Current Limited P-Channel Switch

Pin Descriptions

Pin #	Symbol	Function
1, 2	IN	These pins are the input to the P-channel MOSFET source. Connect a 1μF capacitor from IN to GND.
3	$\overline{\text{ON}}$	Active low enable input. A logic low turns the switch on.
4	GND	Ground.
5	SET	Current limit set input. A resistor from SET to ground sets the current limit for the switch.
6, 7	OUT	These pins are the P-channel MOSFET drain connection. Connect a 1μF capacitor from OUT to GND.
8	$\overline{\text{FAULT}}$	Fault indication output. This open-drain output goes low when in current limit or when the die temperature exceeds +135°C, with a 2ms delay after the fault event occurs.

Pin Configuration

**SOP-8
(Top View)**

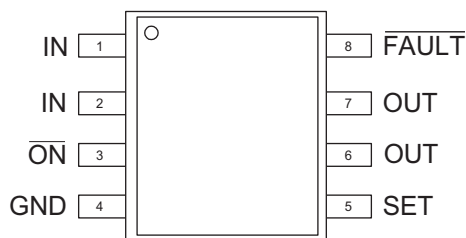

**MSOP-8
(Top View)**

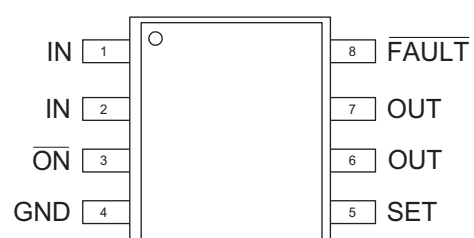

AAT4601A***1.8A Current Limited P-Channel Switch*****Absolute Maximum Ratings¹**

$T_A = 25^\circ\text{C}$, unless otherwise noted.

Symbol	Description	Value	Units
V_{IN}	IN to GND	-0.3 to 6	V
V_{ON}, V_{FAULT}	$\overline{ON}, \overline{FAULT}$ to GND	-0.3 to $V_{IN} + 0.3$	V
V_{SET}, V_{OUT}	SET, OUT to GND	-0.3 to $V_{IN} + 0.3$	V
I_{MAX}	Maximum Continuous Switch Current	3	A
T_J	Operating Junction Temperature Range	-40 to 150	$^\circ\text{C}$
T_{LEAD}	Maximum Soldering Temperature (at Leads)	300	$^\circ\text{C}$
V_{ESD}	ESD Rating—HBM ²	4000	V

Thermal Characteristics³

Symbol	Description	Value	Units
θ_{JA}	Maximum Thermal Resistance	SOP-8	100
		MSOP-8	150
P_D	Maximum Power Dissipation	SOP-8	1.25
		MSOP-8	833

1. Stresses above those listed in Absolute Maximum Ratings may cause permanent damage to the device. Functional operation at conditions other than the operating conditions specified is not implied.
2. Human body model is a 100pF capacitor discharged through a 1.5k Ω resistor into each pin.
3. Mounted on an FR4 printed circuit board.

AAT4601A**1.8A Current Limited P-Channel Switch****Electrical Characteristics**

$V_{IN} = 5V$, $T_A = -40^{\circ}C$ to $+85^{\circ}C$, unless otherwise noted. Typical values are $T_A = 25^{\circ}C$.

Symbol	Description	Conditions	Min	Typ	Max	Units
V_{IN}	Operation Voltage		2.7		5.5	V
I_Q	Quiescent Current	$V_{IN} = 5V$, $\overline{ON} = GND$, $I_{OUT} = 0$		12	30	μA
$I_{Q(OFF)}$	Off-Supply Current	$\overline{ON} = IN$, $V_{IN} = 5.5V$		0.004	1	μA
$I_{SD(OFF)}$	Off-Switch Current	$\overline{ON} = IN$, $V_{IN} = 5.5V$, $V_{OUT} = 0$		0.07	15	μA
V_{UVLO}	Under-Voltage Lockout	Rising Edge, 1% Hysteresis	2.0	2.3	2.7	V
$R_{DS(ON)}$	On Resistance	$V_{IN} = 5.0V$		70	120	m Ω
		$V_{IN} = 4.5V$		75	130	
		$V_{IN} = 3.0V$		80	150	
		$V_{IN} = 3.0V$, $T_A = 25^{\circ}C$		80	110	
I_{LIM}	Current Limit	$R_{SET} = 20.5k\Omega$	750	1000	1250	mA
$I_{LIM(MIN)}$	Minimum Current Limit			260		mA
OTMP	Shutdown Temperature	$V_{IN} = 5V$		125		$^{\circ}C$
V_{ONL}	\overline{ON} Input Low Voltage				0.8	V
V_{ONH}	\overline{ON} Input High Voltage	$V_{IN} = 2.7V$ to $3.6V$	2.0			V
		$V_{IN} = 4.5V$ to $5.5V$	2.4			
I_{ONSINK}	\overline{ON} Input leakage	$V_{ON} = 5.5V$		0.01	1	μA
V_{FAULTL}	\overline{FAULT} Logic Output Low Voltage	$I_{SINK} = 1mA$		0.08	0.4	V
I_{FSINK}	\overline{FAULT} Logic Output High Leakage	$V_{FAULT} = 5.5V$		0.05	1	μA
T_{RESP}	Current Limit Response Time	$V_{IN} = 5V$		2		μs
T_{BLANK}	Fault Blanking Time After Turn-On			2		ms
T_{OFF}	Turn-Off Time ¹	$V_{IN} = 5V$			20	μs
T_{ON}	Turn-On Time ¹	$V_{IN} = 5V$			200	μs

1. Guaranteed by design.

AAT4601A

1.8A Current Limited P-Channel Switch

Typical Characteristics

Unless otherwise noted, $V_{IN} = 5V$, $T_A = 25^\circ C$.

Quiescent Current vs. Temperature

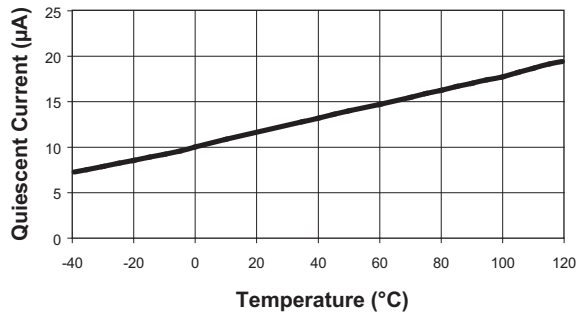

Quiescent Current

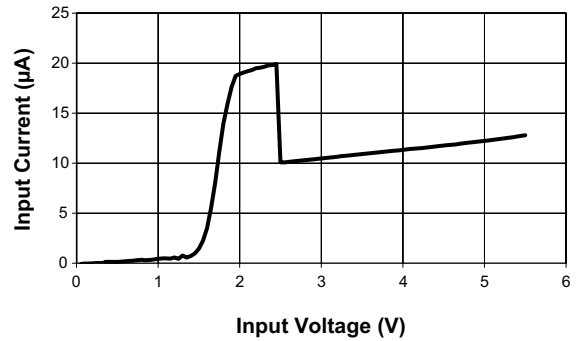

Current Limit
($R_{SET} = 20.5k\Omega$; $V_{IN} = 5.0V$)

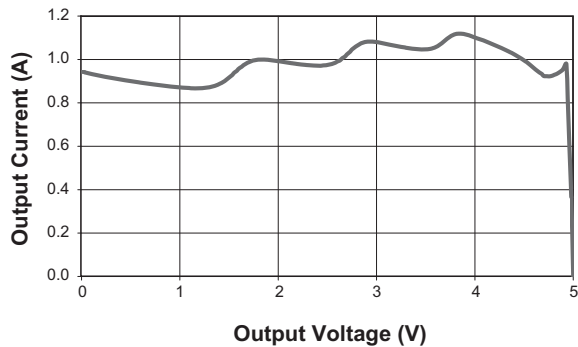

$R_{SET} I_{LIM}$ Product vs. I_{LIM}

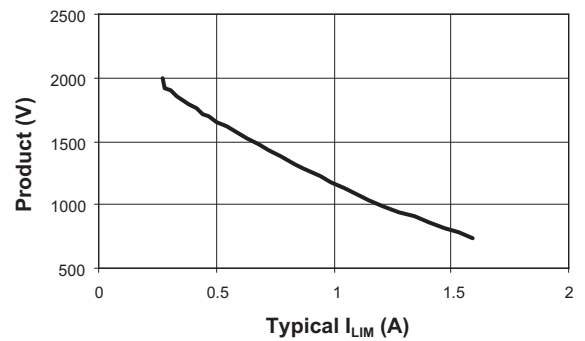

Off-Supply Current vs. Temperature

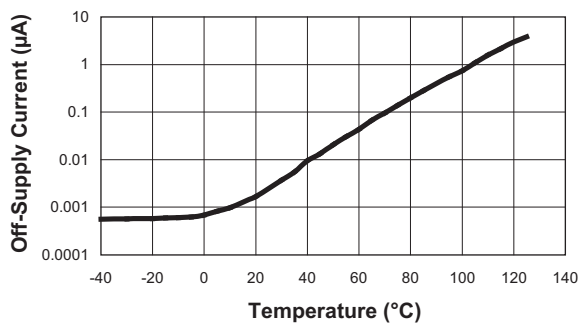

Off-Switch Current vs. Temperature

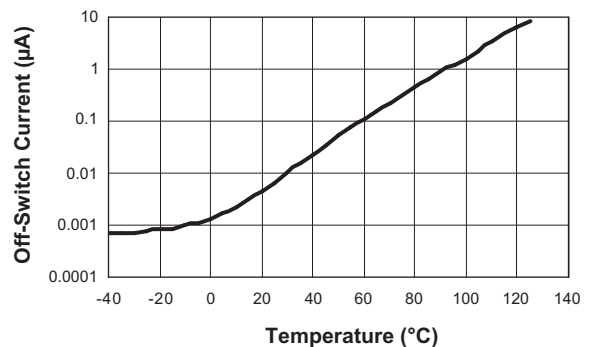

AAT4601A

1.8A Current Limited P-Channel Switch

Typical Characteristics

Unless otherwise noted, $V_{IN} = 5V$, $T_A = 25^\circ C$.

Turn-On Time vs. Temperature

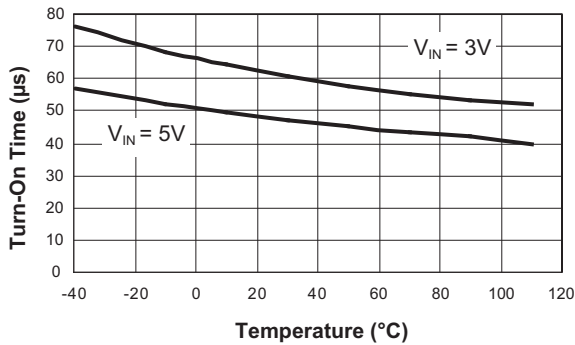

Turn-Off Time vs. Temperature

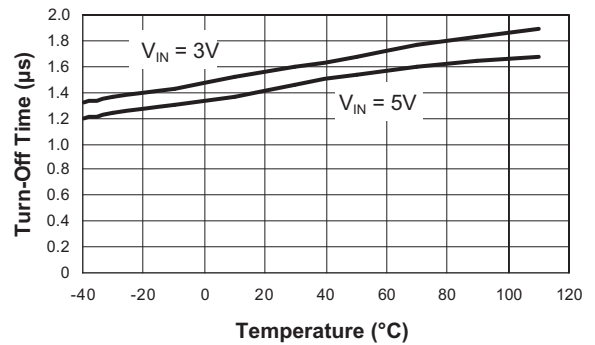

Switch Turn-On Time

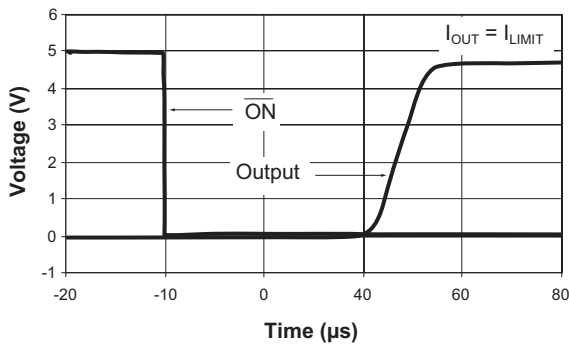

Switch Turn-Off Time

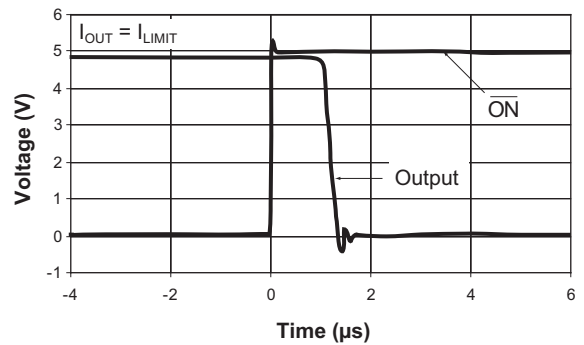

Short-Circuit Through 0.3Ω

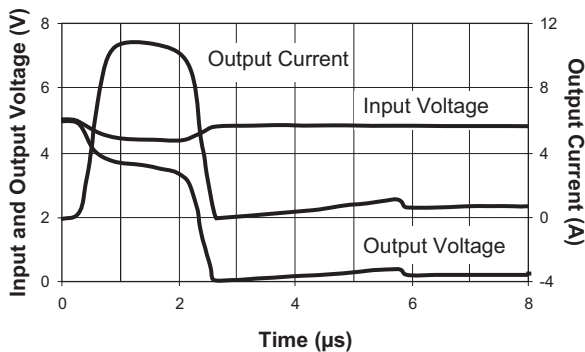

Short-Circuit Through 0.6Ω

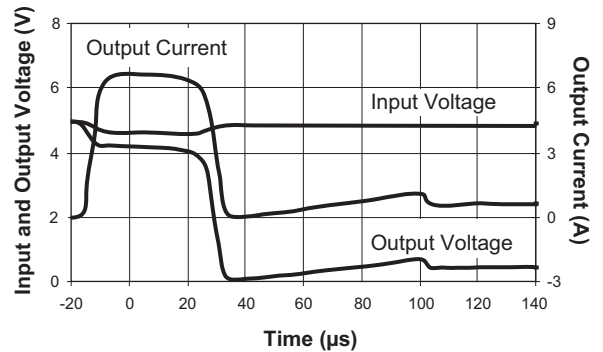

AAT4601A

1.8A Current Limited P-Channel Switch

Typical Characteristics

Unless otherwise noted, $V_{IN} = 5V$, $T_A = 25^\circ C$.

Fault Delay vs. Temperature

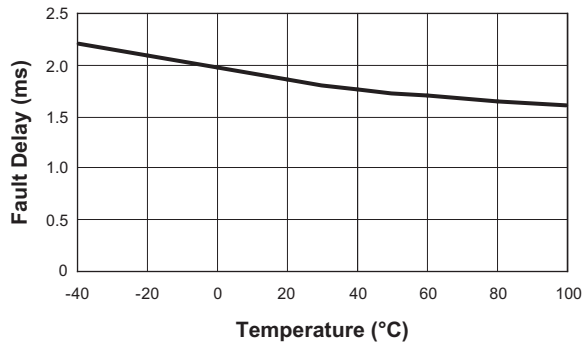

$R_{DS(ON)}$ vs. Temperature

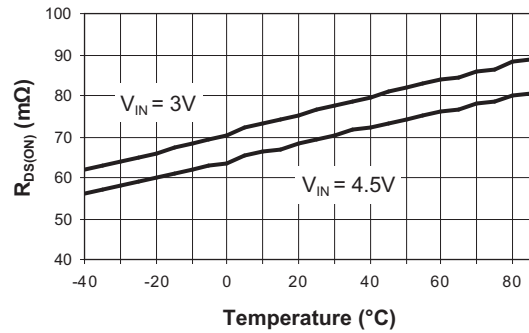

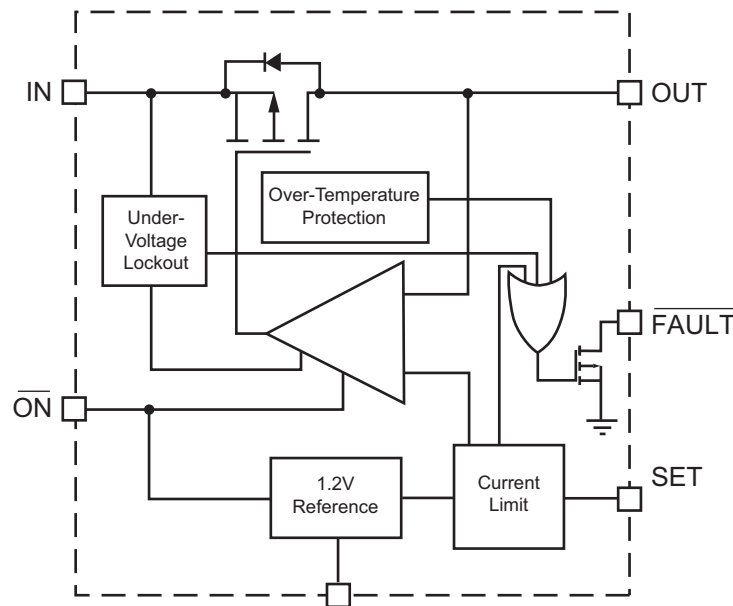
Functional Block Diagram**Functional Description**

The AAT4601A is an integrated MOSFET load switch with an adjustable current limit, over-temperature protection, level-shifted input, and a fault flag. The current limit control is combined with an over-temperature thermal limit circuit to provide a comprehensive system to protect the load switch under short-circuit or other adverse operating conditions. The AAT4601A is ideally suited for control and protection of peripheral ports such as USB, RS232, and parallel ports.

The current limit and over-temperature circuits will act independently. The device current limit is activated when the output load current exceeds an internal threshold level. The internal current limit threshold is determined by an external resistor connected between the SET pin and ground. The minimum current limit threshold is specified by $I_{LIM(MIN)}$. If the load switch ambient temperature becomes excessive or if a short-circuit condition persists, the die temperature will rise causing the over-temperature protection circuit to activate.

If a current limit level less than $I_{LIM(MIN)}$ is required, the AAT4601A can be used to operate in foldback current limit mode. To achieve this, an R_{SET} value can be chosen to program a current limit lower than $I_{LIM(MIN)}$; in this case, when the load current reaches $I_{LIM(MIN)}$, the current will immediately drop, limiting at the programmed value.

If the current limit or over-temperature protection circuits are active for more than 2ms, the system will be informed via the \overline{FAULT} flag. The 2ms delay allows the AAT4601A to be turned on into capacitive loads without activating the \overline{FAULT} flag. The open drain \overline{FAULT} output can be connected directly to system controllers driven by voltage levels less than the IN pin voltage without additional level shifting circuitry.

The load switch is turned off by applying a logic high level to the \overline{ON} pin. The AAT4601A typically consumes $12\mu A$ when operating; when off, the device draws less than $1\mu A$. In the off state, current is prevented from flowing between the input and output. The \overline{ON} function has logic level thresholds that allow the AAT4601A to be TTL compatible and may also be controlled by 2.5V to 5.0V CMOS circuits. The voltage level on either \overline{ON} or \overline{FAULT} should not exceed the input supply level present on the IN pin.

1.8A Current Limited P-Channel Switch

Applications Information

Setting Current Limit

A simple three-step procedure can be used to adjust the AAT4601A's current limit. First, the maximum current required by the load should be determined. Second, select a resistor that guarantees adequate current is available to the load under normal conditions. Finally, the maximum current that can pass through the switch can be calculated and compared to the maximum current available.

Step 1: The maximum current required by a load is usually defined in port specifications design application references. For example, USB ports may be specified to support loads of up to 500mA.

Step 2: The most convenient method for determining a current limit resistor value is to look it up in Table 1, "Current Limit R_{SET} Values." Find the lowest current value that is greater than the maximum load current in the given application as listed in the column, "Device Will Not Current Limit Below." The resistor value needed is listed in the corresponding row in the column, " R_{SET} ." For example, a USB port requires 500mA. The lowest level where the device will current limit above 500mA is 507mA. The corresponding resistor value for R_{SET} would be 33k Ω .

Step 3: Now the required resistor value has been determined. The maximum current that can be drawn, even with a short circuit applied to the output, can be determined by reading the column, "Device Always Current Limits Below." If the power supply connected to the AAT4601A's input can provide this current level, the power supply voltage will not collapse when a short circuit is applied to the load switch output. For example, a notebook computer has a USB port which is powered by an AAT4601A with a 33k Ω resistor connected between the SET pin and GND. If the power supply connected to the AAT4601A's IN pin can provide more than 845mA, this supply will remain in regulation even if a short circuit is applied to the USB port.

R_{SET} (k Ω)	Current Limit Typ (mA)	Device Will Not Current Limit Below (mA)	Device Always Current Limits Below (mA)
7.5	2476	1857	3095
8.2	2277	1708	2847
9.1	2065	1549	2581
10	1895	1421	2369
11	1748	1311	2185
12	1633	1224	2041
13	1528	1146	1910
15	1353	1015	1691
16	1280	960	1600
18	1158	869	1448
20	1055	791	1318
22	972	729	1215
24	897	673	1122
27	811	608	1014
30	736	552	919
33	676	507	845
36	625	469	781
39	582	436	727
43	533	400	666
47	491	368	613
51	455	341	568
56	418	314	523
62	380	285	476
68	350	262	437
75	320	240	400
82	295	221	369
91	267	200	334
100	245	183	306
110	223	167	279
120	206	155	258
130	192	144	239
150	167	125	209
160	157	118	197

Table 1: Current Limit R_{SET} Values.

AAT4601A

1.8A Current Limited P-Channel Switch

Operation in Current Limit

If an excessive load is applied to the output of an AAT4601A, the load current will be limited by the device's current limit circuitry as shown in Figure 1, "Overload Operation." If a short circuit were to occur on the load, it would demand more current than allowed by the internal current limiting circuit and the voltage at the AAT4601A's output would drop. This causes the AAT4601A to dissipate more power than in normal operation, causing the die temperature to increase. When die temperature exceeds the internal over-temperature threshold, the AAT4601A will shut down. After shutting down, the AAT4601A cools to a level below the over-temperature threshold, at which point it will start up again. The AAT4601A will continue to cycle off and on until one of the following events occurs: the load current is reduced to a level below the AAT4601A's current limit setting; the input power is removed; or the output is turned off by a logic high level applied to the $\overline{\text{ON}}$ pin.

Thermal Considerations

Since the AAT4601A has internal current limit and over-temperature protection, junction temperature is rarely a concern. If an application requires a large load current in a high-temperature operating environment, there is the possibility that the over-temperature protection circuit, rather than the current limit circuit, will regulate the current available to the load. In these applications, the maximum current available without risk of activation of the over-temperature circuit can be calculated. The maximum internal temperature while current limit is not active can be calculated using Equation 1:

$$\text{Eq. 1: } T_{J(\text{MAX})} = I_{\text{MAX}}^2 \cdot R_{\text{DS(ON)(MAX)}} \cdot R_{\theta\text{JA}} + T_{\text{A(MAX)}}$$

In Equation 1, I_{MAX} is the maximum current required by the load. $R_{\text{DS(ON)(MAX)}}$ is the maximum rated $R_{\text{DS(ON)}}$ of the AAT4601A at high temperature. $R_{\theta\text{JA}}$ is the thermal resistance between the AAT4601A's die and the board onto which it is mounted. $T_{\text{A(MAX)}}$ is the maximum ambient temperature for the printed circuit board assembly under the AAT4601A when the load switch is not dissipating power. Equation 1 can be transformed to provide I_{MAX} ; refer to Equation 2:

$$\text{Eq. 2: } I_{\text{MAX}} = \sqrt{\frac{T_{\text{SD(MIN)}} - T_{\text{A(MAX)}}}{R_{\text{DS(ON)(MAX)}} \cdot R_{\theta\text{JA}}}}$$

$T_{\text{SD(MIN)}}$ is the minimum temperature required to activate the AAT4601A's over-temperature protection. With a typical specification of 125°C, 115°C is a safe minimum value to use.

For example, a portable device is specified to operate in a 50°C environment. The printed circuit board assembly will operate at temperatures as high as 85°C. This portable device has a sealed case and the area of the printed circuit board assembly is relatively small, causing $R_{\theta\text{JA}}$ to be approximately 120°C/W. Using Equation 2:

$$\text{Eq. 3: } I_{\text{MAX}} = \sqrt{\frac{115^\circ\text{C} - 85^\circ\text{C}}{0.13\Omega \cdot 120^\circ\text{C/W}}} = 1.4\text{A}$$

If this system requires less than 1.4A, the thermal limit will not activate during normal operation.

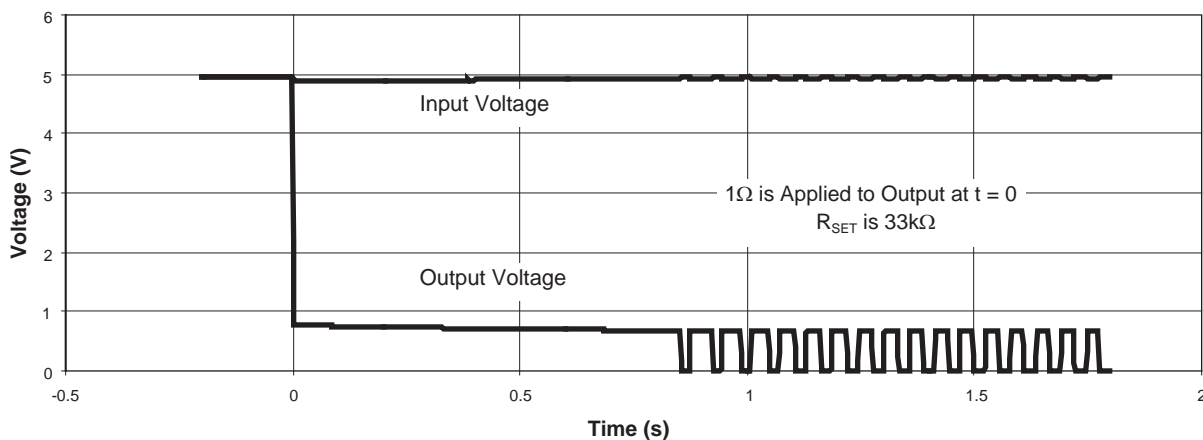

Figure 1: Overload Operation.

AAT4601A

1.8A Current Limited P-Channel Switch

Input Capacitor

The input capacitor serves two purposes. First, it protects the source power supply from transient current effects generated by the application load circuit. If a short circuit is suddenly applied to the output of an AAT4601A, there is a microsecond-long period during which a large current can flow before the current limit circuitry activates; refer to the characteristic curve, "Short-Circuit Through 0.3Ω." A properly sized input capacitor can dramatically reduce the load switch input transient response effects seen by the power supply and other circuitry upstream from the AAT4601A.

The second purpose of the input capacitor is to prevent transient events generated by the load circuit from affecting operation of the AAT4601A. For example, if an AAT4601A is used in a circuit that operates from a 3V power supply with poor step load response, it is possible that turning on the load switch could cause the input power supply to droop below the AAT4601A's undervoltage lockout threshold. This drop in voltage would cause the AAT4601A to turn off until the input power supply's voltage recovers. Since this cycle would be self-perpetuating, the entire circuit could be seen to be unstable. In the very rare case where capacitor cost is prohibitive, the output load circuit should be slew rate limited when turned on.

Output Capacitor

In order to insure stability while the device current limit is active, a small capacitance of approximately 1μF should be used. When the AAT4601A is activated using the $\overline{\text{ON}}$ function, there are no momentary current transients, as in the case when a short circuit is suddenly applied to a device that is already on; refer to the characteristic curve, "Switch Turn-On Time." No matter how big the output capacitor, output current is limited to the value allowed by the threshold determined by R_{SET} and the internal current limiting circuitry. This permits very large output capacitors to be used.

For example, USB ports are specified to have at least 120μF of downstream capacitance from their controlling power switch. An output capacitance as large as 1000μF would not disturb the input power supply to the AAT4601A used to control the USB port.

ON Input

When the AAT4601A is in the off state, the output is an open circuit and the device quiescent current consump-

tion is reduced to less than 1μA. The $\overline{\text{ON}}$ threshold voltage is set to allow the AAT4601A to be controlled by 5V TTL levels as well as CMOS power from 2.5V to 5V. The $\overline{\text{ON}}$ function control voltage level should not exceed the input supply level applied to the IN pin.

FAULT Output

A $\overline{\text{FAULT}}$ flag is provided to alert a system if the load switch is not receiving a sufficient voltage level to properly operate. If either the current limit or over-temperature circuits in any combination are continuously active for more than approximately 2ms, the $\overline{\text{FAULT}}$ pin is pulled to ground internally through a 100Ω resistance. The 2ms delay on the $\overline{\text{FAULT}}$ function is intended to prevent capacitive loads connected to the load switch output from activating $\overline{\text{FAULT}}$ when the device is turned on. The placement of a pull-up resistor between the $\overline{\text{FAULT}}$ pin and the IN pin is recommended. Reasonable values for the pull-up resistor should range from 10kΩ to 100kΩ. Since $\overline{\text{FAULT}}$ is an open drain terminal, it may be pulled up to any voltage that is not greater than the level present on the IN pin. This is done to allow the AAT4601A to signal ancillary circuitry that is powered by a voltage level less than the level on the IN pin.

Reverse Voltage

The AAT4601A is designed to control current flowing from IN to OUT. If a voltage is applied to OUT that is greater than that on IN, a large resulting reverse current may flow, potentially damaging the AAT4601A.

Printed Circuit Board Layout Recommendations

For proper thermal management, and to take advantage of the low $R_{\text{DS(ON)}}$ of the AAT4601A, a few circuit board layout rules should be followed: V_{IN} and V_{OUT} should be routed using wider than normal traces, and GND should be connected to a ground plane. For best performance, C_{IN} and C_{OUT} should be placed close to the package pins.

Evaluation Board Layout

The AAT4601A evaluation layout follows the printed circuit board layout recommendations and can be used for good applications layout.

Note: Board layout shown is not to scale.

AAT4601A

1.8A Current Limited P-Channel Switch

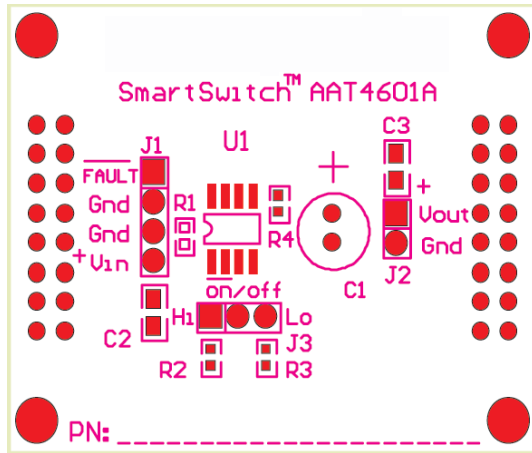

Figure 1: AAT4601A Evaluation Board Top Side Silk Screen Assembly Drawing.

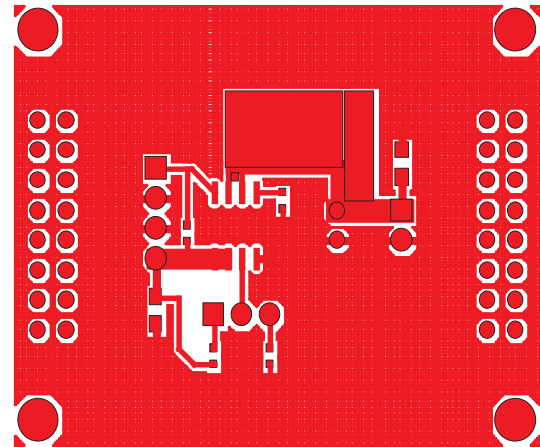

Figure 2: AAT4601A Evaluation Board Component Side Layout.

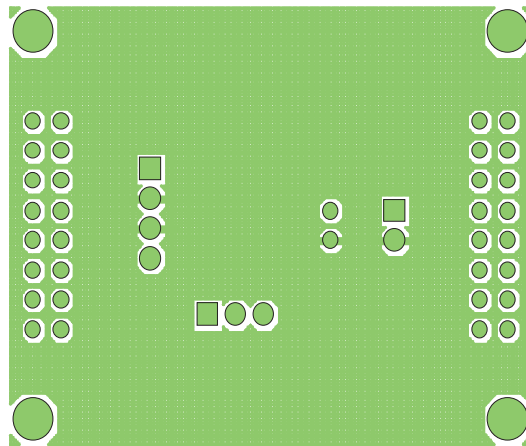

Figure 3: AAT4601A Evaluation Board Solder Side Layout.

AAT4601A

1.8A Current Limited P-Channel Switch

Ordering Information

Package	Marking ¹	Part Number (Tape and Reel) ²
SOP-8	4601A	AAT4601AIAS-T1
MSOP-8	MQXY	AAT4601AIKS-T1



Skyworks Green™ products are compliant with all applicable legislation and are halogen-free.

For additional information, refer to *Skyworks Definition of Green™*, document number SQ04-0074.

Package Information

SOP-8

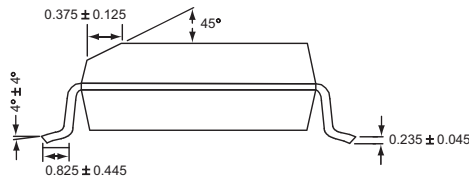
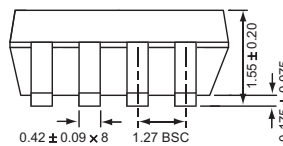
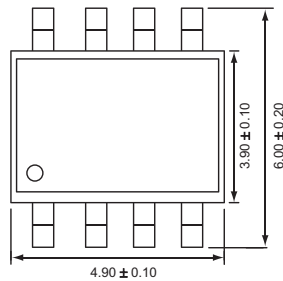

All dimensions in millimeters.

1. XYZ = assembly and date code.
2. Sample stock is generally held on part numbers listed in **BOLD**.

DATA SHEET

AAT460IA

1.8A Current Limited P-Channel Switch

MSOP-8

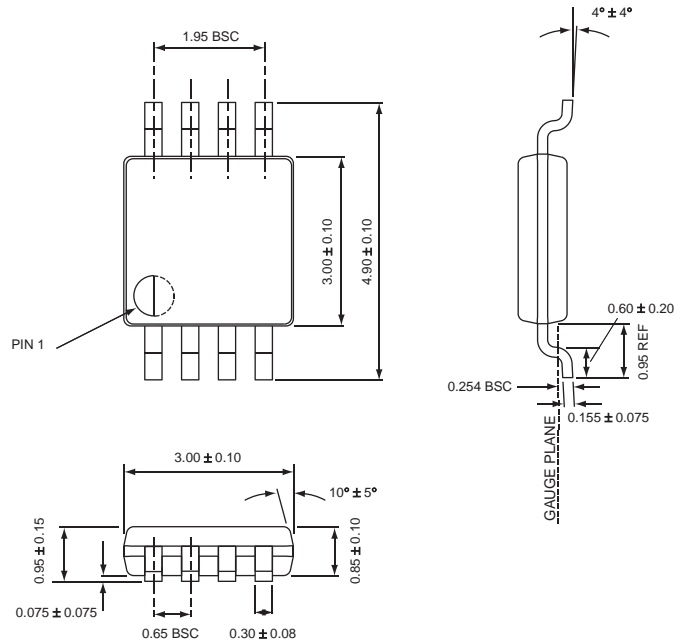

All dimensions in millimeters.

Copyright © 2012 Skyworks Solutions, Inc. All Rights Reserved.

Information in this document is provided in connection with Skyworks Solutions, Inc. ("Skyworks") products or services. These materials, including the information contained herein, are provided by Skyworks as a service to its customers and may be used for informational purposes only by the customer. Skyworks assumes no responsibility for errors or omissions in these materials or the information contained herein. Skyworks may change its documentation, products, services, specifications or product descriptions at any time, without notice. Skyworks makes no commitment to update the materials or information and shall have no responsibility whatsoever for conflicts, incompatibilities, or other difficulties arising from any future changes.

No license, whether express, implied, by estoppel or otherwise, is granted to any intellectual property rights by this document. Skyworks assumes no liability for any materials, products or information provided hereunder, including the sale, distribution, reproduction or use of Skyworks products, information or materials, except as may be provided in Skyworks Terms and Conditions of Sale.

THE MATERIALS, PRODUCTS AND INFORMATION ARE PROVIDED "AS IS" WITHOUT WARRANTY OF ANY KIND, WHETHER EXPRESS, IMPLIED, STATUTORY, OR OTHERWISE, INCLUDING FITNESS FOR A PARTICULAR PURPOSE OR USE, MERCHANTABILITY, PERFORMANCE, QUALITY OR NON-INFRINGEMENT OF ANY INTELLECTUAL PROPERTY RIGHT; ALL SUCH WARRANTIES ARE HEREBY EXPRESSLY DISCLAIMED. SKYWORKS DOES NOT WARRANT THE ACCURACY OR COMPLETENESS OF THE INFORMATION, TEXT, GRAPHICS OR OTHER ITEMS CONTAINED WITHIN THESE MATERIALS. SKYWORKS SHALL NOT BE LIABLE FOR ANY DAMAGES, INCLUDING BUT NOT LIMITED TO ANY SPECIAL, INDIRECT, INCIDENTAL, STATUTORY, OR CONSEQUENTIAL DAMAGES, INCLUDING WITHOUT LIMITATION, LOST REVENUES OR LOST PROFITS THAT MAY RESULT FROM THE USE OF THE MATERIALS OR INFORMATION, WHETHER OR NOT THE RECIPIENT OF MATERIALS HAS BEEN ADVISED OF THE POSSIBILITY OF SUCH DAMAGE.

Skyworks products are not intended for use in medical, lifesaving or life-sustaining applications, or other equipment in which the failure of the Skyworks products could lead to personal injury, death, physical or environmental damage. Skyworks customers using or selling Skyworks products for use in such applications do so at their own risk and agree to fully indemnify Skyworks for any damages resulting from such improper use or sale.

Customers are responsible for their products and applications using Skyworks products, which may deviate from published specifications as a result of design defects, errors, or operation of products outside of published parameters or design specifications. Customers should include design and operating safeguards to minimize these and other risks. Skyworks assumes no liability for applications assistance, customer product design, or damage to any equipment resulting from the use of Skyworks products outside of stated published specifications or parameters.

Skyworks, the Skyworks symbol, and "Breakthrough Simplicity" are trademarks or registered trademarks of Skyworks Solutions, Inc., in the United States and other countries. Third-party brands and names are for identification purposes only, and are the property of their respective owners. Additional information, including relevant terms and conditions, posted at www.skyworksinc.com, are incorporated by reference.